

Mobile Label Printer RPP322 Series

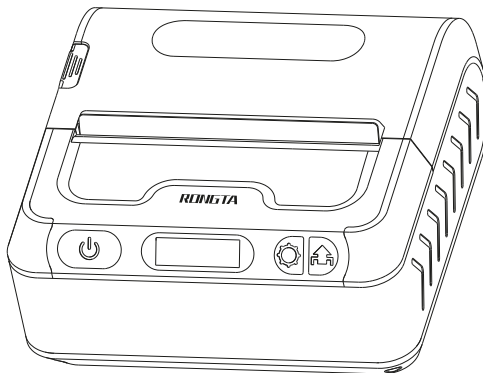

Please read this Manual carefully before using the printer and keep it for future reference

Contents

Preface.....	1	4.4 Auto sleep/wake	11
About This Manual	1	4.5 Enter setting screen.....	12
Icons and Practices	1	V. Communication	13
Related Manual Information.....	1	5.1 USB Communication	13
Safety Instruction	2	5.2 WiFi Communication	14
I. Standard Configuration	5	5.3 Bluetooth Communication	14
II. Appearance and Components	6	VI. Repair and Maintenance.....	15
III. Preparation Before Use.....	8	6.1 Daily Maintenance of Printer	15
3.1 Battery Installation.....	8	6.2 Use and Storage of Printing Paper	15
3.2 Battery Charging	9	VII. Troubleshooting.....	16
3.3 Printing Paper Loading.....	10	VIII. Appendix.....	17
IV. Basic Functions	11	8.1 Printer Parameters	17
4.1 Power On.....	11	8.2 Battery Recycling.....	18
4.2 Power Off.....	11	IX. FCC WARNING	19
4.3 FEED.....	11		

Preface

About This Manual

Thank you for purchasing the RPP322 mobile printer produced by Rongta.

This Manual can help you easily learn to use this product. Please read this Manual carefully before using the printer and keep it properly so that everyone who uses this product can read it.

Icons and Practices

For your convenience, this Manual uses the following symbols (icons) and practices:

 **WARNING** warns that improper use may result in property damage, serious injury or death.

 **ATTENTION** indicates that improper use may result in personal injury or property damage.

 **NOTE** indicates that the information listed allows you to use the product better or extend the service life of the product.









Related Manual Information





Various manuals provide detailed instructions for various technical problems.

 The illustrations and text used in this Manual may differ from the actual product.





Safety Instruction







Please follow the following precautions when using the printer:

-  **ATTENTION** Do not disassemble the printer by yourself. Please read this Manual carefully before use.
-  **WARNING** Please turn off the power immediately in case of failure. When you notice smoke or odor coming from the printer or power adapter, please unplug the power adapter and remove the battery immediately. Please be careful not to get burnt.
-  **WARNING** Please do not use the printer near gas stations, fuel warehouses and other flammable materials.
-  **WARNING** During charging, the printer and power adapter must be placed in a ventilated place with the ambient temperature of 0°C - 45°C, and be sure to use the power adapter provided by the Company. The use of unapproved power adapters may be hazardous and also violates our warranty policy.
-  **ATTENTION** When the printer is printing, please do not open the cover of the paper bin; otherwise, unpredictable conditions may occur and the printer may even be damaged.
-  **ATTENTION** After printing, the print head is still at a high temperature. Do not touch it to avoid burns.
-  **ATTENTION** Please do not use dissolved matter (such as benzene thinner) to wipe the printer shell, and please keep the printer away from corrosive chemicals. You can only gently wipe the printer with a clean soft cloth.
-  **ATTENTION** Please use our original or approved printing paper; otherwise, it may lead to poor printing quality or even damage to the printer mechanism.







-  **ATTENTION** If the printer is to be stored for a long time, be sure to remove the battery from the printer and store it separately; otherwise, the battery may fail or even have leakage, which may damage the printer.
-  **ATTENTION** Make sure the printer is turned off before replacing the battery. If a power adapter is used, make sure the power is cut off before replacing the battery.
-  **ATTENTION** The printer can work stably at an ambient temperature of 0°C - 40°C. Too high or too low ambient temperature will lead to low printing quality.
-  **ATTENTION** The time that the printed text can be kept on the thermal printing paper is related to the paper quality. To print documents that need to be kept for a long time, please use long-lasting thermal printing paper.

Please follow the following precautions when using the battery:

-  **ATTENTION** Please carefully read this Manual and symbols on the battery surface before use.
-  **WARNING** Please charge the battery in a cool and ventilated room. The high ambient temperature during charging will cause the battery to heat up, emit smoke, burn, deform, or even explode.
-  **WARNING** There are special protective circuits and devices inside the battery. Please do not disassemble the battery by yourself, or it will cause a short circuit or electrolyte leakage.
-  **WARNING** There is a risk of blindness if the electrolyte gets into the eye. In case of eye contact, rinse immediately with water and seek doctor's advice immediately.





-  **WARNING** Do not squeeze, mechanically vibrate or shake the battery, and short circuit of the battery is strictly forbidden.
-  **WARNING** Please do not put the battery into water; otherwise, it may result in internal short circuit, which may cause the battery to heat up, emit smoke, deform, damage or even explode.
-  **ATTENTION** Do not expose the battery to direct sunlight or put it in a place with excessive smoke and dust. Do not use the battery in a high humidity environment, such as a bathroom.
-  **ATTENTION** Please replace the battery if it cannot meet the performance requirements.
-  **ATTENTION** Keep the battery out of reach of children to prevent danger.
-  **ATTENTION** If you notice any discoloration or deformation of the battery, stop using it immediately.

Please carefully read this Manual and symbols on the surface of power adapter before use.

-  **ATTENTION** Do not disassemble or modify the power adapter. Do not use the power adapter if the power line is damaged; otherwise, it may cause electric shock, fire and damage to the power adapter.
-  **WARNING** Do not touch the power adapter with wet hands. If the power adapter comes into contact with water or other liquids, cut off the power supply immediately.
-  **WARNING** Please avoid short circuit, vibration or shaking of the power adapter.
-  **WARNING** Do not use the power adapter in a high humidity environment, such as a bathroom. The equipment is not waterproof and must not be exposed to rain or moisture.
-  **WARNING** Hold the power adapter body when unplugging. Simply pulling the power line will damage the wires.
-  **ATTENTION** Keep the power adapter out of reach of children to prevent danger.

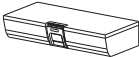
I. Standard Configuration



Printer (1 set)	Battery (1 pcs)	USB cable (1 pcs)
		
Quick Installation Guide(1 pcs)	Power adaptor (1 pcs)	
		

☺ The pictures are for reference only. If any item is damaged or missing, please contact the supplier.

II. Appearance and Components



□ Front View

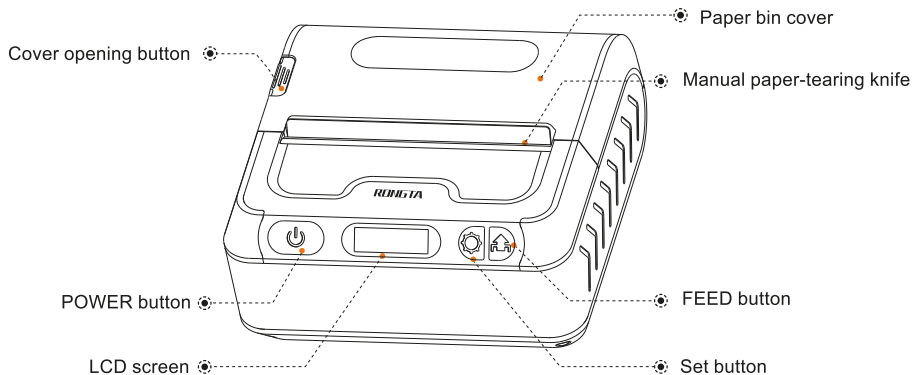

□ Inside View

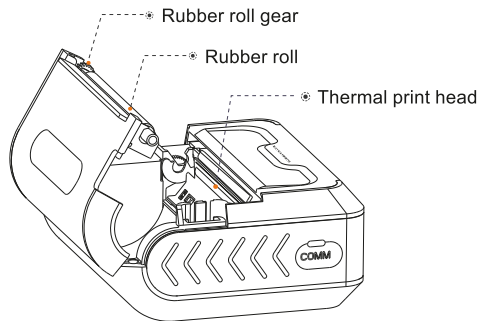

□ Rear View

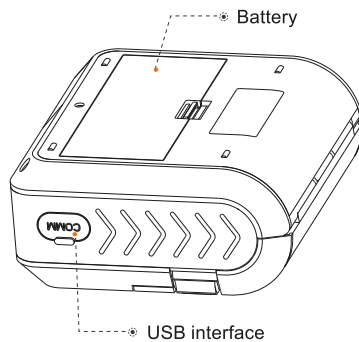

III. Preparation Before Use



This chapter describes the steps to prepare the printer, including battery installation, battery charging, and printing paper loading.

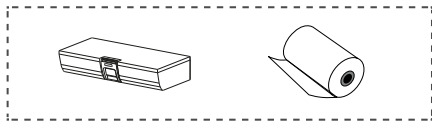

3.1 Battery Installation

The battery is installed in the printer before the product leaves factory.

- (1) Remove the protective film of battery contacts.
- (2) Install the battery as shown in the figure above.
- (3) Fasten the battery.

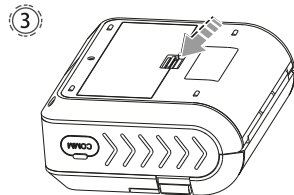
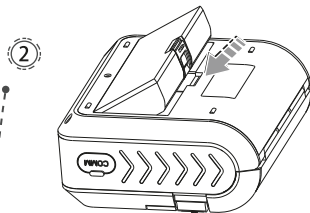
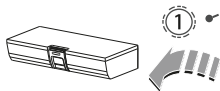

3.2 Battery Charging

1. Standby charging

Insert the power adapter plug into the power socket, and the USB interface into the printer charging port (AC:100V~240V(50/60Hz)).

Charging:Battery indication icon  scroll display of battery indication slot.

End of charging:Battery indication icon shows  full battery, The buzzer will alert with a "beep" sound.

WARNING

If you use a power adapter not provided or approved by us, the printer may be damaged.

NOTE

You can print while charging.

The equipment supports fast charge function and can continue to print after short-time charging.

ATTENTION

Do not remove the battery while charging.

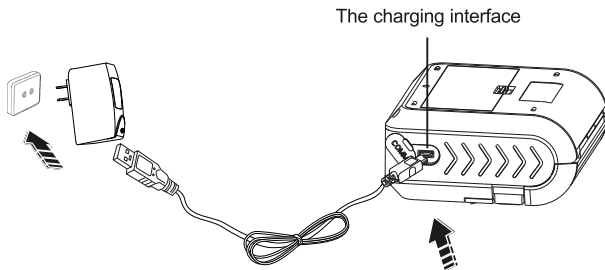

3.3 Printing Paper Loading

1. Remove the seal of the paper roll;
2. Press the open button to open the paper compartment, turn the baffle wrench to unlock, and adjust the paper width baffle to the paper width;
3. Put the paper roll into the paper bin, fine-tune the paper width baffle to lean against the paper roll, turn the paper width baffle wrench to fix it;
4. Pull out a part of the paper along the exit and close the paper bin cover.

①



②

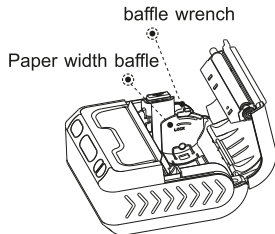

③

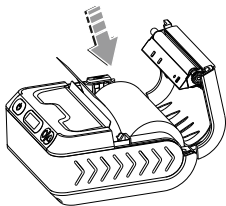

④

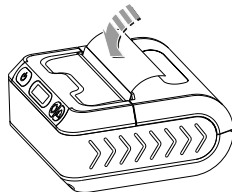

☺ NOTE:

1. Paper specification used by the printer: Paper width: 80mm, paper roll diameter: 43mm.
2. Pay attention to the direction of paper roll. If it is placed in the wrong direction, it will lead to blank printing.

IV. Basic Functions



■ Function description of buttons

4.1 Power On

Press and hold the POWER button for 3 seconds to turn on the printer.

4.2 Power Off

When the printer is on, press and hold the POWER button to turn it off.

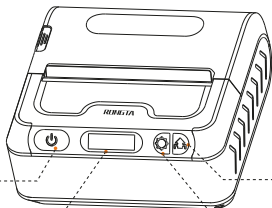

POWER button

LCD screen

FEED button

Set button

4.3 FEED

Press the FEED button (under continuous feeding mode, press FEED button to feed paper of about 5mm; under label/black label mode, press FEED button to feed paper to seam label or black label.)

4.4 Auto sleep/wake

Auto sleep

When the printer is turned on and has no button operation or data transmission within 5 seconds, it will automatically enter sleep mode. The screen display is shown in the figure.



Auto wake

When the printer is in sleep mode, it can be woke up by pressing the POWER button or when receiving data.













4.5 Enter setting screen

Enter setting screen: During power-on state (non-sleep mode), press and hold SET button to enter the option screen.

Press SET button: Go to the next option.

Press FEED button: Change option parameters.

Press POWER button: Confirm settings and exit.

 ●○○○○○○○○○○○◀▶ Do: Print Info	print self-test page	Press Power button to start printing self-test page
 ●○○○○○○○○○○○◀▶ Print Quality: 0-4	0-4	Set wide range definition (coarse tuning)
 ●○○○○○○○○○○○◀▶ Darkness: 0-4	0-4	Set small range definition (fine tuning)
 ●○○○○○○○○○○○◀▶ Speed: 0-4	0-4	Set print speed
 ●○○○○○○○○○○○◀▶ Language: English	EngLish	Set language
 ●○○○○○○○○○○○◀▶ Buzzer Set: Open	Open	Set whether to turn on the buzzer
 ●○○○○○○○○○○○◀▶ Paper Type: Label	Label	Set according to the paper type used
 ●○○○○○○○○○○○◀▶ Power Feed: Open	Open	Set whether to feed paper upon power-on
 ●○○○○○○○○○○○◀▶ Cover Feed: Open	Open	Set whether to feed paper upon closing the cover
 ●○○○○○○○○○○○◀▶ Screen Saver: 10	10/30/60/99S	Set screensaver time
 ●○○○○○○○○○○○◀▶ Auto Shutdown: -	1-5H	Set auto shutdown
 ●○○○○○○○○○○○◀▶ Cmd Model: CPCL	ESC/CPCL	Set command mode
 ●○○○○○○○○○○○◀▶ Paper Size: 80	80/58 mm	Set according to the paper width

V. Communication



5.1 USB Communication

The printer provides USB port, which is used to connect the printer to a PC as shown in the figure to charge the printer, set parameters, and transmit data, etc.

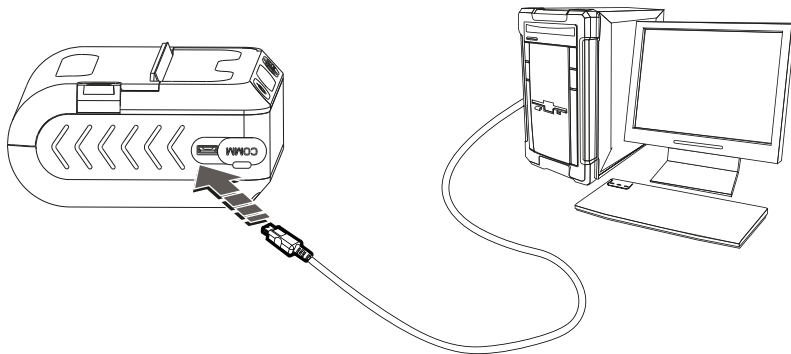

5.2 WiFi Communication (Alternative)

The mobile label printer can provide WiFi communication, and support STA mode and TPIK/AES encryption. Its effective communication distance is no more than 20m.



 WiFi information can be changed through the setting tool. For details, please refer to the "Instruction Manual for Setting Tool".

5.3 Bluetooth Communication

1. The mobile label printer can provide dual-mode Bluetooth 4.0/5.2 (SPP + BLE), which can communicate with Android system and IOS system terminals. Its effective communication distance is no more than 10m.



 The default pairing password of Bluetooth is 1234 and the parameters can be set through the setting tool. For details, please refer to the "Instruction Manual for Setting Tool".

VI. Repair and Maintenance



6.1 Daily Maintenance of Printer

1. Cleaning of outside and paper bin: Wipe the surface of the printer and the inside of the paper bin gently with a wrung-out wet cloth. Make sure that the wet cloth is completely wrung out.
2. Cleaning of printer mechanism: The printer mechanism must be cleaned regularly, especially when the print quality declines. The cleaning method is as follows: Use absorbent cotton moistened with anhydrous alcohol to gently wipe the stains or the residue glue of label paper on the surface of the printer mechanism until it is clean.
3. If water is found inside the printer, Turn it of immediately, remove the battery, and dry the printer by airing.
4. If the printer will not be used for a long time, remove the battery and store it separately.

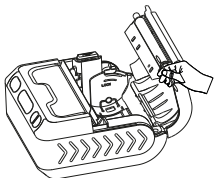

6.2 Use and Storage of Printing Paper

1. Please keep newly purchased printing paper in intact package and prevent it from direct sunlight and high temperature.
2. Please keep printed documents in a dark place at room temperature (about 20°C), so as to effectively extend the storage life of the documents.
3. If the documents need to be kept for a long time, please use long-lasting thermal printing paper.

VII. Troubleshooting



Fault Phenomenon	Cause	Solution
Paper is fed but no data is printed.	Printing paper is loaded in the wrong direction.	Please load the printing paper in the other direction.
Blurry printing	The printer is not cleaned for a long time and the printer mechanism is contaminated by dirt.	Clean the printer mechanism.
	Poor color rendering of printing paper	Please set higher blackness or use paper with better color rendering
Printed documents are blurred in months or even weeks	Poor quality of printing paper	Please use long-lasting thermal printing paper
	Documents are kept at high ambient temperature	Please keep the documents at room temperature (about 20°C)

VIII. Appendix



8.1 Printer Parameters

Printing Parameters	
Printing method	Thermal line printing
Print width	80mm
Paper roll diameter	Max ϕ 43mm
Print speed	90mm/s
Resolution	203dpi
Built-in font	GB18030 Simplified Chinese (standard)
Service life of printer mechanism	Continuous paper: 150km label paper: 50km
Command set	TSC/CPCL/ESC/POS compatible
Print length	>200m
Print content	One-dimensional code: Code 39, 39C, I25, Code 93, ITF25, EAN128, Code 128, Codabar, EAN-8, EAN8+2, EAN8+5, EAN-13, EAN13+2, EAN13+5, UPC-A, UPCA+2, UPCA+5, UPC-E, UPCE+2, UPCE+5 MSIC, ITF14, EAN14, CODE11, POST QR code: QR CODE, PDF417 (optional)

Printing Parameters	
Dot density	576dot/line
Input power supply	5V $\overline{=}$ 1A / 5V $\overline{=}$ 2A
Battery specification	7.4V 2000mAh rechargeable lithium ion battery
Charging time	4-6 hours
Working environment	Temperature: 0°C~45°C, humidity: 20%~90%
Storage environment	Temperature: -10°C~60°C, humidity: 10%~90% (Except paper rolls)
Interface	Bluetooth+USB Interface
Size of receive buffer	8MB SDRAM/2MB PSRAM

☺ **Note:** The interface is optional or customized, and the specific interface is subject to the actual object.

8.2 Battery Recycling

This product uses a rechargeable lithium battery. To protect the environment, please do not dispose of used batteries at will. The supplier will provide you with battery recycling service.

IX. FCC WARNING



FCC Statement:

This device complies with part 15 of the FCC Rules. Operation is subject to the following two conditions: (1) This device may not cause harmful interference, and (2) this device must accept any interference received, including interference that may cause undesired operation.

This equipment has been tested and found to comply with the limits for a Class B digital device, pursuant to part 15 of the FCC Rules. These limits are designed to provide reasonable protection against harmful interference in a residential installation. This equipment generates, uses and can radiate radio frequency energy and, if not installed and used in accordance with the instructions, may cause harmful interference to radio communications. However, there is no guarantee that interference will not occur in a particular installation. If this equipment does cause harmful interference to radio or television reception, which can be determined by turning

the equipment off and on, the

user is encouraged to try to correct the interference by one or more of the following measures:

- Reorient or relocate the receiving antenna.
- Increase the separation between the equipment and receiver.
- Connect the equipment into an outlet on a circuit different from that to which the receiver is connected.
- Consult the dealer or an experienced radio/TV technician for help.

Caution: Any changes or modifications not expressly approved by the party responsible for compliance could void the user's authority to operate the equipment.

This equipment complies with FCC radiation exposure limits set forth for an uncontrolled environment. This transmitter must not be co-located or operating in conjunction with any other antenna or transmitter.



Rongta Technology (Xiamen) Group Co., Ltd.

ADD: No.88, Tonghui South Road, Tongan, Xiamen,China.

WEB: www.rongtatech.com

TEL: 0086-592-5666129 FAX: 0086-592-5659169